

# LEA

CERAMICHE

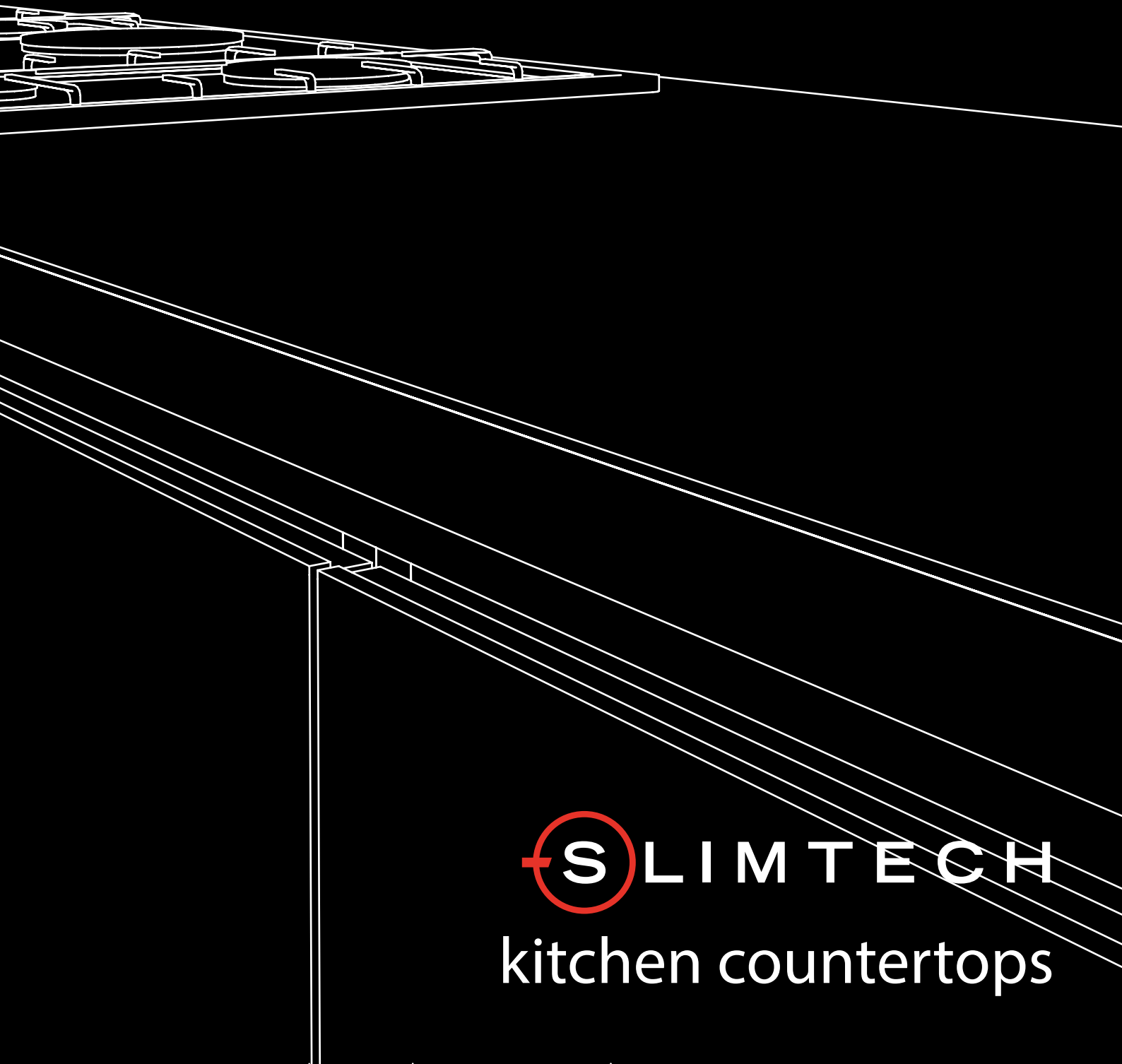

SLIMTECH

kitchen countertops

# Contents

---

<b>01</b>	<b>CONSTRUCTING A KITCHEN COUNTERTOP</b>	<b>7</b>
<hr/>		
<b>02</b>	<b>SLIMTECH</b>	<b>8</b>
2.1 -	What is SLIMTECH	8
2.2 -	SLIMTECH 3mm, SLIMTECH 3PLUS, SLIMTECH 5PLUS and other versions on demand	8
2.3 -	Physical and chemical characteristics	9
2.4 -	Microban® antimicrobial technology	11
2.4.1 -	What is Microban®	
2.4.2 -	Microban® Protection. Why ?	
2.4.3 -	Advantages of Microban® technology	
2.4.4 -	Compliance with safety norms	
2.4.5 -	How Microban® technology works	
2.4.6 -	Thoroughly tested applications	
<hr/>		
<b>03</b>	<b>WORKING WITH THE VARIOUS VERSIONS OF SLIMTECH</b>	<b>12</b>
3.1 -	Manual processing	12
3.2 -	Machine processing	14
3.3 -	Constructing the angle	16
3.3.1 -	Solution 1	
3.3.2 -	Solution 2	
<hr/>		
<b>04</b>	<b>INSTALLING THE VARIOUS VERSIONS OF SLIMTECH</b>	<b>18</b>
4.1 -	Supporting material	18
4.1.1 -	Supporting material: requirements	
4.1.2 -	Support: most common types of substrates	
4.2 -	Recommended adhesives	19
4.3 -	Instructions for installation	20
4.3.1 -	Instructions for manual installation: applying adhesive	
4.3.2 -	Instructions for manual installation: installing the tile	
<hr/>		
<b>05</b>	<b>CONNECTING PROFILES, FINISHING AND TRIM PIECES</b>	<b>21</b>
<hr/>		
<b>06</b>	<b>KITCHEN COUNTERTOP CLEANING INFORMATION</b>	<b>22</b>
6.1 -	Day to day cleaning	22
6.1.1 -	Resistance to cold liquids	
6.2 -	Heavy duty cleaning	23
<hr/>		
<b>07</b>	<b>USEFUL CONTACTS</b>	<b>24</b>







## CONSTRUCTING A KITCHEN COUNTERTOP

The purpose of this document is to provide information and technical knowledge necessary to construct a kitchen countertop. The following is the result of research that has involved, together with the Panariagroup Research Centre, different market-leading businesses that operate in the field of kitchen countertops and the world's leading manufacturers of adhesives.

Basically a kitchen countertop is made of:

1. SLIMTECH, in its different versions, is the countertop finishing element (see "2 - SLIMTECH" );
2. An adhesive that will bind the support to SLIMTECH, in its different versions (see "4.2 - recommended adhesives" );
3. A support on which SLIMTECH is installed, in its different versions (see "4.1 - Supporting material" ).

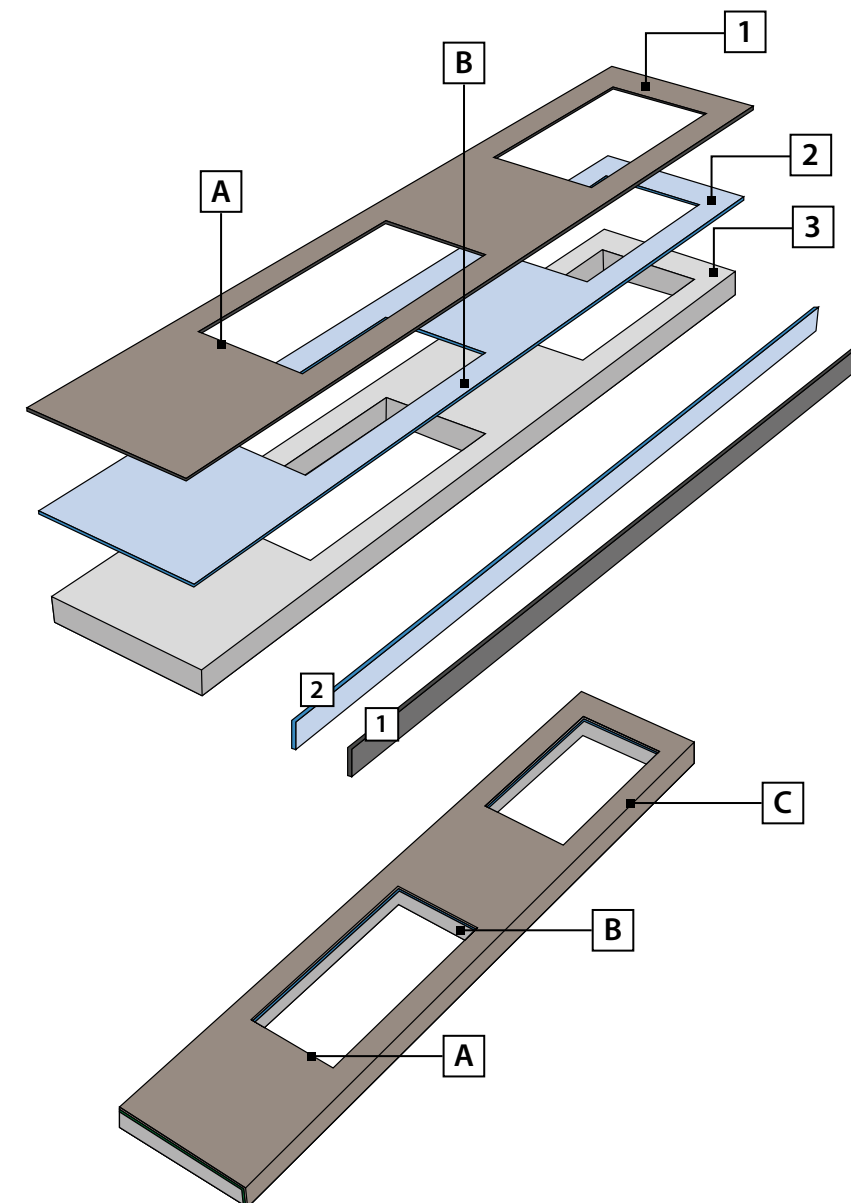

The operations that are necessary for the construction of the kitchen countertop are:

- A. Cutting and drilling SLIMTECH, in its different versions, to create the holes for faucets, space for wash basins, etc. (see "3 - working with the various versions of SLIMTECH" );
- B. Installing SLIMTECH, in its different versions (see "4.3 - Instructions for installation" );
- C. Finishing touches to give the countertop a seamless look. These operations usually involve the edges and corners and are necessary to hide the junction points, for example, between the vertical edge and the horizontal surface (see "3.3 - Constructing the angle" ).

The sequence of the processes may change depending on the requirements of the manufacturer of the countertop.



## SLIMTECH

### 2.1 - What is SLIMTECH

SLIMTECH is the result of the latest technology. It is produced in the 300x100 cm format with a thickness of 3 mm and 5mm, using a porcelain mixture composed of top quality clay and raw materials. It is pressed at a force of 15,000 tons. Firing takes place in innovative and ecological kilns that are the result of the research and know-how of Panariagroup. SLIMTECH tiles are resistant to heat, stains, scratches and their surface is totally non-absorbent. Dirt, bacteria, fungi or other mould pathogens cannot penetrate the surface of the product. The heat resistance guaranteed by SLIMTECH makes it possible to place hot pots or dishes directly on the top.

### 2.2 - SLIMTECH 3mm, SLIMTECH 3PLUS, SLIMTECH 5PLUS and other versions on demand

SLIMTECH (in all its versions) is a suitable material for kitchen countertops. The choice between the different versions is at the discretion of the person in charge of constructing the kitchen countertop. The most commonly used versions are SLIMTECH 3PLUS and SLIMTECH 3mm. For the better mechanical characteristics and special surface finishes one can opt for SLIMTECH 5PLUS or SLIMTECH 5mm (only on demand). The SLIMTECH double-layer version is to be used in situations where the support given by the substrate is not continuous (e.g metallic structures)

#### SLIMTECH 3mm

3 mm  
Thickness

Porcelain stoneware tiles with a thickness of 3 mm, in sizes up to 300x100 cm.  
**Must be bonded to a suitable substrate.**

#### SLIMTECH 3PLUS

3.5 mm  
Thickness

Porcelain stoneware tiles with a thickness of 3.5 mm, **reinforced with fibreglass mesh on rear side**, in sizes up to 300x100 cm.  
**Must be bonded to a suitable substrate.**

#### SLIMTECH 5PLUS

5.5 mm  
Thickness

Porcelain stoneware tiles with a thickness of 5.5 mm, **reinforced with fibreglass mesh on rear side**, in sizes up to 300x100 cm.  
**Must be bonded to a suitable substrate.**

\* Only on demand

#### SLIMTECH 5mm

5 mm  
Thickness

Porcelain stoneware tiles with a thickness of 5 mm, in sizes up to 300x100 cm.  
**Must be bonded to a suitable substrate.**

#### SLIMTECH DOUBLE-LAYER

7 mm.  
Thickness

"Double-layer" tiles in porcelain stoneware of 7 mm thickness consisting of two tiles of SLIMTECH 3mm coupled and reinforced with **a fibreglass mesh**, in sizes up to 300x100 cm.

### Physical and chemical characteristics

	Technical Characteristics	Standard / Test Method	Values SLIMTECH 3mm	Values SLIMTECH 3PLUS	Values SLIMTECH 5PLUS	* Only on demand	
						Values SLIMTECH 5mm	Values SLIMTECH DOUBLE-LAYER
	Density	ISO 14617-1 ASTM C97	2300 - 2500 kg/m <sup>3</sup>	2300 - 2500 kg/m <sup>3</sup>	2300 - 2500 kg/m <sup>3</sup>	2300 - 2500 kg/m <sup>3</sup>	2300 - 2500 kg/m <sup>3</sup>
	Water absorption	ISO 14617-1 ASTM C97	≤ 0,05%	≤ 0,05%	≤ 0,05%	≤ 0,05%	≤ 0,05%
	Bending strength	ISO 14617-2	(Depending on the type of support)	(Depending on the type of support)	(Depending on the type of support)	(Depending on the type of support)	≥ 50 MPa
	Compression strength	ISO 14617-15	(Depending on the type of support)	(Depending on the type of support)	(Depending on the type of support)	(Depending on the type of support)	392 MPa
	Frost-resistance	ISO 14617-5	KM f25 = 1	KM f25 = 1	KM f25 = 1	KM f25 = 1	KM f25 = 1
	Resistance to dry heat	EN 12722	5 (No visible effect to a maximum test temperature of 160 °C)	5 (No visible effect to a maximum test temperature of 160 °C)	5 (No visible effect to a maximum test temperature of 160 °C)	5 (No visible effect to a maximum test temperature of 160 °C)	5 (No visible effect to a maximum test temperature of 160 °C)
	Resistance to dry heat	EN 438-2 PAR.16	5 (No visible effect to a maximum test temperature of 180°C)	5 (No visible effect to a maximum test temperature of 180°C)	5 (No visible effect to a maximum test temperature of 180°C)	5 (No visible effect to a maximum test temperature of 180°C)	5 (No visible effect to a maximum test temperature of 180°C)
	Chemical Resistance to household cleaning products	ISO 14617-10	C4 No visible effect	C4 No visible effect	C4 No visible effect	C4 No visible effect	C4 No visible effect
	Resistance to cold liquids	EN 12720	5 No visible effect	5 No visible effect	5 No visible effect	5 No visible effect	5 No visible effect
	Resistance to cold liquids (Cleaning products)	CATAS procedure (**)	5 (No change)	5 (No change)	5 (No change)	5 (No change)	5 (No change)
	Deep abrasion resistance	ISO 14617-4	30.0 mm.	30.0 mm.	30.0 mm.	30.0 mm.	30.0 mm.
	Scratch resistance	UNI 9428	5 No visible effect	5 No visible effect	5 No visible effect	5 No visible effect	5 No visible effect
	Antimicrobial Activity Microban*	ISO 22196	Up to 99%	Up to 99%	Up to 99%	Up to 99%	Up to 99%
	Resistance to fungi	ASTM G21	No fungal growth	No fungal growth	No fungal growth	No fungal growth	No fungal growth
	Hygiene	CATAS procedure (**)	Excellent (percentage removal of bacteria >99% after cleaning with non-antimicrobial detergent)	Excellent (percentage removal of bacteria >99% after cleaning with non-antimicrobial detergent)	Excellent (percentage removal of bacteria >99% after cleaning with non-antimicrobial detergent)	Excellent (percentage removal of bacteria >99% after cleaning with non-antimicrobial detergent)	Excellent (percentage removal of bacteria >99% after cleaning with non-antimicrobial detergent)
	Release of lead and cadmium	ISO 10545-15	No emission	No emission	No emission	No emission	No emission
	Light Resistance	UNI EN 15187	5 No visible effect	5 No visible effect	5 No visible effect	5 No visible effect	5 No visible effect
	Impact Resistance	EN 14617-9	(Depending on the type of support)	(Depending on the type of support)	(Depending on the type of support)	(Depending on the type of support)	Mean value = 3J

(\*\*) CATAS - centre of research, development, and laboratory tests for the wood, furniture, environment and food sectors.

## 2.4 - Microban® antimicrobial technology

### 2.4.1 - What is Microban®

Microban® International, Ltd. is a leading global company, specialised in enhancing high quality consumer, industrial and medical products with built-in active agents that combat microbial growth. Microban® International owns the Microban® global brand name which partner companies use under license.

The Microban® brand offers continuous and durable antimicrobial product protection, built-in during production so as not wear off during the product's lifecycle. Microban® International is headquartered in North Carolina with operations in North America, South America, Europe and Asia.

Worldwide, Microban® has licensed more than 200 companies, including brands such as Whirlpool, Rubbermaid, Johnson & Johnson, DuPont® and many others which have incorporated Microban® antimicrobial protection into more than 1,000 products, including kitchen and bathroom products, apparel and home textiles, appliances, building materials, food-service products, medical products and others.

### 2.4.2 - Microban® Protection. Why ?

Bacteria and other micro-organisms are a fact of life. They are everywhere, all around us, all the time. However hard we try, there's no getting away from them. Some are beneficial and other neutral. However some are dangerous. So it makes sense to do what we can to prevent their potentially harmful and undesirable effects.

Under right conditions of warmth, a food source and humidity, bacteria can multiply extremely rapidly. Bacterial populations can double as quickly as every 20 minutes. In addition, bacteria can persist on inert surfaces for a long time. On average, there may be more bacteria on your hand than people on Earth.

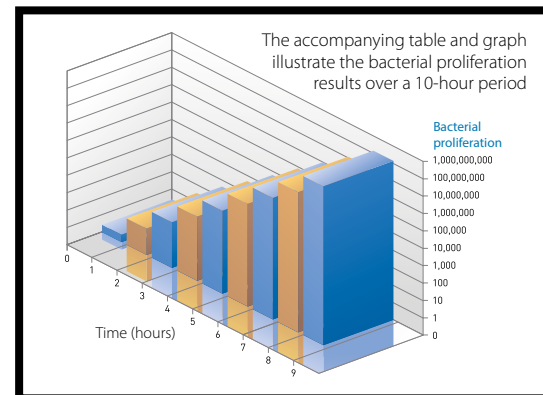

### 2.4.3 - Advantages of Microban® technology

On the tile surface, the Microban® antimicrobial technology is effective in reducing bacterial growth up to 99.9%. Efficacy evaluation is carried out by independent laboratories using the International Standard ISO 22196.

The Microban antimicrobial® additive:

- Is permanently integrated in the tile surface during the firing process at 1200°C, lasting for the lifetime of the product. It is not a surface treatment applied after firing and does not need to be re-applied over time. This is due to the fact that the additive is a permanent part of the tile structure.
- Is uniformly applied in the surface, and it is therefore active also in difficult-to-reach flooring areas.
- Offers a continuous protection, 24 h a day, day and night, with and without sunlight, and it does not need UV lamp activation to display antimicrobial efficacy (unlike other technologies).
- Can be applied to tiles of any colour. It does not whiten the tile surface where it is applied (unlike other technologies).



### 2.4.4 - Compliance with safety norms

The antimicrobial silver based technology used in Panariagroup ceramic tiles has a long history of safe use and can be found in a wide range of consumer, industrial and healthcare products. The antimicrobial properties of silver have been known to cultures all around the world for many centuries.

The use and choice of Microban® antimicrobial technologies for Panariagroup laminated porcelain and porcelain tiles is in full compliance with global regulatory bodies which govern the use and applications on the market. In the United States, the Environmental Protection Agency (EPA) has regulatory jurisdiction and in the EU, the biocidal active components of Microban® antimicrobial additives are notified in accordance with the Biocidal Products Regulation (BPR) No 528/2012 for the relevant product types in accordance with their end use application.

**The Microban® additive used in Panariagroup ceramic tile products is also approved for use in direct food contact applications regulated under the Food Contact Materials Framework Regulation (EC) No. 1935/2004. It is also registered with the EPA (Environmental Protection Agency) and FDA (Food and Drug Administration) in the United States of America.**

### 2.4.5 - How Microban® technology works

#### Antimicrobial & Hygienic technology

Microban® provides round the clock protection against the growth of bacteria.

Microban® technology functions in numerous ways to inhibit bacterial growth. Protein and enzyme activity is blocked and the organism's DNA is damaged. The metal ions included in the Microban® additive are able to bind to many targets and stop important cellular functions.

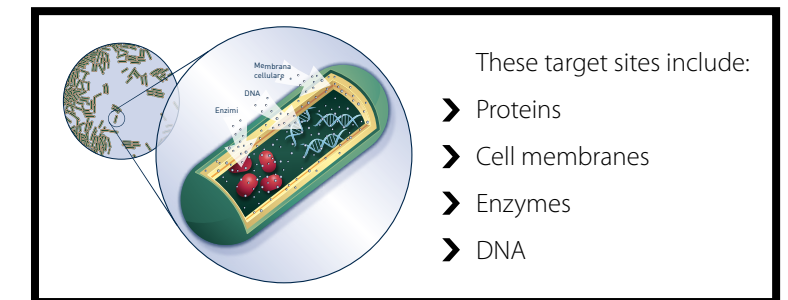

Key proteins, for example are denatured and therefore prevent the bacteria from multiplying on the surface. With the removal of essential survival proteins, the bacteria will be unable to reproduce causing the death of the organism.

As Microban® antimicrobial technology is incorporated into the tile surface during the manufacturing process, it continuously fights the growth of bacteria for the lifetime of the product. Unlike surface disinfectants which only have a limited residual activity, Microban® protection works continuously eliminating bacteria and keeping the tiled surface more hygienic between cleanings.

Microban® antimicrobial additives have a biocidal action which kills bacteria that colonize and grow on the ceramic tile surface – this action is only on the tiled surface and; does not create a sterilized environment. Sterilization is defined as a process where 100% of living micro-organisms including bacterial spores are killed. For this to be maintained, however, the surface or product must be kept in a sterile environment.

Everyday the surface of the tiles is continually subject to bacterial contamination; the advantage of antimicrobial technology is that it continuously lowers bacterial count. As bacteria come into contact with the tiled surface containing Microban® technology, the elimination cycle commences. It is this ongoing cycle of elimination that supports hygiene measures and helps prevent cross-contamination.

With the Microban® brand you can be sure you are getting continuous, durable and effective antimicrobial protection supported by the Microban® Certification Programme, a quality assurance programme individually tailored to each Microban® partner and product application. Microban® treated Lea tiles, for example, are tested on a regular basis using the International ISO 22196 standard in order to substantiate the biocidal claims.



### 2.4.6 - Thoroughly tested applications

To substantiate the antimicrobial claims, Lea and Microban® use both the Microban® internal expert microbiology laboratory for testing as well as external independent laboratories which are highly specialized in carrying out the ISO 22196 test, such as IMSL in the UK and Artest in Italy.

Tested organisms include Staphylococcus aureus, Escherichia coli and Klebsiella pneumonia.



## WORKING WITH THE VARIOUS VERSIONS OF SLIMTECH

A striking feature of SLIMTECH is its extreme ease-of-installation; this material can be easily cut, shaped and drilled both by tile layers and by specialised craftsmen (stone cutters, glass-workers, etc.) using automatic machines and tools for porcelain stoneware, glass and marble. For manual operations and when using mechanical tools (such as, for instance, angle grinders, drills, cutters and electrical drills), it is recommended to wear gloves, masks for protection against dust and goggles.

If you have to drill holes for pipes or perform cuts for switch boxes or other items, you must choose SLIMTECH 3PLUS, SLIMTECH 5PLUS or the custom made SLIMTECH double-layer.

### 3.1 - Manual processing

#### PREPARATION

It is essential to work on a flat and clean surface; for this it is possible to use the cover of the 300x100 cm pallet.

#### CUTTING WITH A GLASS CUTTER OR MANUAL TILE CUTTER



**Fig. 1** - You can obtain excellent results in terms of shaping and clear cuts by scoring all versions of SLIMTECH with Silberschnitt 2000 special glass cutters produced by **Bohle Italia** or with the manual tile cutter produced by **Würth**. To achieve good cuts, throughout the entire cutting operation never detach the glass cutter from the tile.



**Fig.2** - So as to score the tile in a straight line, one can use aluminium straightedges normally used by builders.



**Fig.3** - After scoring, it is sufficient to bend the slab to detach the two pieces.



**Fig.4** - For SLIMTECH 3PLUS and SLIMTECH 5PLUS, once the tile has been scored and the tile split, the cutting process is completed by cutting the fibreglass with a common cutter.



**Fig.5** - A practical tool for cutting is the tile cutter ruler (for instance Keracut from **Sigma** or Free-cut from **Raimondi**). As far as SLIMTECH 3PLUS and SLIMTECH 5PLUS are concerned, after scoring the ceramic part and splitting the slab, complete the operation by cutting the fibreglass mesh with a standard cutter (Fig.4).



**Fig.6** - With tile cutter rulers, you can use hand-held angle grinders, fitted into special frames that can be "fit onto" the cutting guide. In this manner, you can provide both 90° and 45° cuts to obtain bevels and jolly pieces.

#### CUTTING WITH DIAMOND DISCS



**Fig. 7** - All versions of SLIMTECH can be cut using diamond discs fitted onto hand-held electrical grinding machine. Disc rotation speed must be high (>10000 RPM) and a low feed rate (< 1 m/min). Depending on the type of disc and the length of the cut, it may be necessary to cool the disc with water. Recommended discs are the thin types generally used for cutting porcelain stoneware. The advantages of this type of cut include ease-of-execution and the possibility to cut during installation.

#### DRILLING



**Fig.8** - As far as manual drilling is concerned, use tungsten bits with a diameter up to 10 mm, fitted to electric drills or battery-operated screwdrivers.



**Fig.9/10** - As an alternative, you can use cutting discs fitted to angle grinders, electrical drills or battery-operated screwdrivers.



#### INTERNAL CUT / L-SHAPED CUT



**Fig.11** - To obtain internal and L-shaped corners, round off the vertex of the internal corner using bits with a radius of at least 5 mm that reduce the risk of breakage. Then cut with diamond discs, taking care to stop moving the cutting tool forward when you reach the hole previously drilled. To drill and cut using diamond discs, follow the instructions provided above.

#### When using these tools:

- cool the point being drilled with water;
- do not exert too much pressure and bear in mind the resistance of the type of laminated stoneware you are working on;
- if you are using tungsten bits, start drilling at a low speed;
- if you are using drills or screwdrivers, do not select hammering mode.

#### EDGE-FINISHING



**Fig.12** - Edges can be finished by hand using abrasive diamond sponges or emery paper. With a light passage on the side of the slab, you can obtain a slightly rounded-off edge or with repeated passages a bevelled effect.



**Fig.13** - The same results can be obtained with sanding discs fitted onto hand-held angle grinders.



**Mechanical tools can also be used after bonding SLIMTECH (in its various versions) to the support.**



## 3.2.2 - Machine Processing



**If you have to drill holes for pipes or perform internal cuts, on tiles that do not have a suitable support, you must choose SLIMTECH 3PLUS, SLIMTECH 5PLUS or the custom made SLIMTECH double-layer.**

Irrespective of the system adopted, the underlying surface must be perfectly flat to prevent vibration and movements of the slab that could lead to breakage or damage to the finish. It is recommended to use diamond tools for porcelain stoneware, in good working order. If you have to drill holes for pipes or perform internal cuts, on tiles that do not have a suitable support; you must choose SLIMTECH 3PLUS, SLIMTECH 5PLUS or the custom made SLIMTECH double-layer. To obtain internal corners and L-shaped cuts, round off the edge of the corner using bits with a radius of at least 5 mm that reduce the risk of breakage. It is recommended to perform a few tests before cutting so as to set up the machine in the best manner possible.

Operating parameters provided in this manual are to be considered as **indicative** and must be perfected and checked by the user depending on the material used and the operations to perform.

### SCORING



**Fig.14** - All types of SLIMTECH can be cut using scoring machines. This operation must be performed on a cutting bench and on the front face of the slab. As far as SLIMTECH 3 3PLUS and SLIMTECH 5PLUS are concerned, if this operation cannot be performed automatically on a cutting bench, the fibreglass mesh must be cut by hand with a cutter. Move the cutting tool forward at a speed of 10 m/min. and in any case at a speed suitable for the finish and colour of the slab. Apply an average pressure of about 1,2 bar. For tiles with light colours, you must exert a pressure of about 1,5 bar.

### CUTTING WITH A DISC



**Fig.15** - All versions of SLIMTECH can be cut with diamond discs. Use discs made especially for porcelain stoneware and in good working order. Disc rotation speed must be high (>2000 RPM) and feed rate low (from 0,5 to 1 m/min.) Depending on the type of disc and the length of the cut, it may be necessary to cool the disc with water. Reduce speed at the start and at the end of the cut.

### CUTTING WITH CNC MACHINES



**Fig.16** - SLIMTECH, in all of its versions, can also be drilled using CNC machines. Cutter rotation speed ranges from 12000 to 18000 RPM, with a feed rate between 0.5 and 1 m/min.

### CUTTING WITH WATERJET MACHINES



**Fig.17** - All versions of SLIMTECH can be drilled with waterjet cutting machines. The feed rate of this operation should be between 2 and 3 m/min.

### DRILLING WITH A CNC MACHINE.

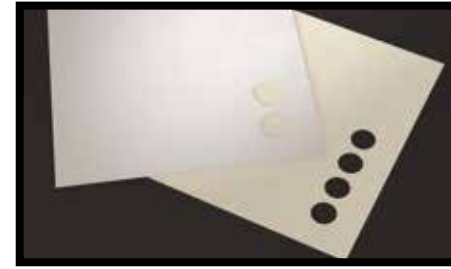

**Fig.18** - SLIMTECH, in all of its versions, can also be drilled using CNC machines. Drill a preliminary hole using a diamond drill bit and if necessary use a hole saw to enlarge the hole to the required dimensions. Use a bit with a diameter of between 4 and 8 mm. Operating speed is 40 mm/min. with spindle rotation of 900 RPM. When using these tools: cool the point drilled with water; start drilling at a low speed; never exert too much pressure and bear in mind the resistance of the type of SLIMTECH you are working on.

### DRILLING WITH A WATERJET MACHINE



**Fig.19** - All versions of SLIMTECH can be drilled with waterjet cutting machines. With waterjet machines, you can obtain holes with a smaller diameter compared to those possible with a numeric control machine. Operating speed must range from 2 to 3 m/min.

### EDGE POLISHING



**Fig.20** - To shape and polish the edge of the slab, use diamond/abrasive discs, which are suitable for obtaining an edge of the shape and size requested. Finish the edge with a polishing disc. Different discs are available for obtaining different edge finishes. Operating speed must be tested beforehand.

### 45° CUT



**Fig.21** - To obtain 45° cuts, use 45° angled diamond discs. In this way, you can join two tiles of SLIMTECH to create a corner. The corner must then be bevelled. Different discs are available for obtaining a variety of edge finishes. Operating speed must be tested beforehand.

### BEVELLING



**Fig.22** - All versions of SLIMTECH can be bevelled. To smooth curved cuts one must use a CNC machine with a 5 axis grinding wheel. Different discs are available for obtaining a variety of edge finishes. Operating speed must be tested beforehand.



**Except for the scoring process, all mechanical tools can also be used after bonding SLIMTECH (in its various versions) to the support.**

3.3 - Constructing the angle

3.3.1 - Solution 1

 The finishing of the edges is usually done using tools commonly used in the processing of natural stones and glass.

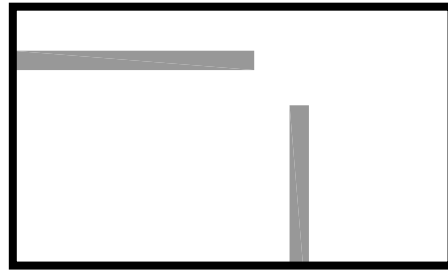

1 - SLIMTECH tile in all its versions.

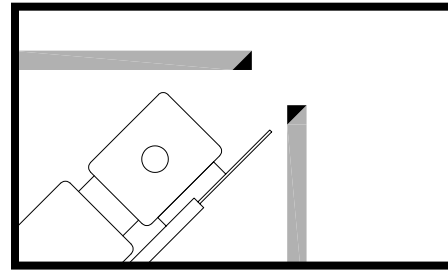

2 - Create a 45° cut on the inner edge of the slab with a hand-held angle grinder or grinder fitted on a guide, such as the 36B bevelling machine made by Sigma.



3 - Spread adhesive on the support.

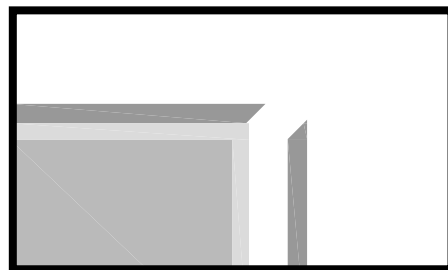

4 - Install the first slab.

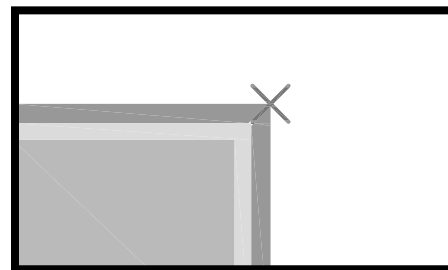

5 - Lay the second slab using 1 mm cross spacers.

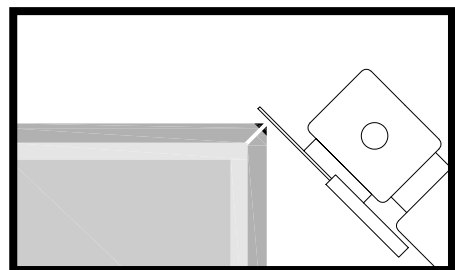

6 - After adhesive has cured, provide a 45° cut with a hand-held angle grinder or grinder fitted on a guide, such as the 36B bevelling machine made by Sigma.

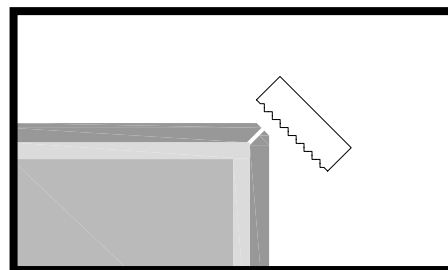

7 - Sand the edge with a diamond finished sponge or grinder disc mounted on a hand-held grinder.

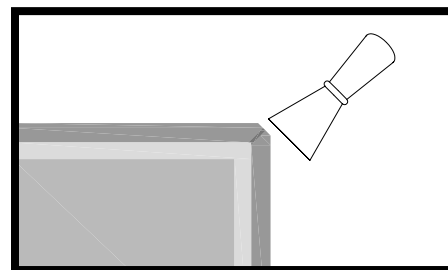

8 - Apply epoxy grout with a trowel (\*).

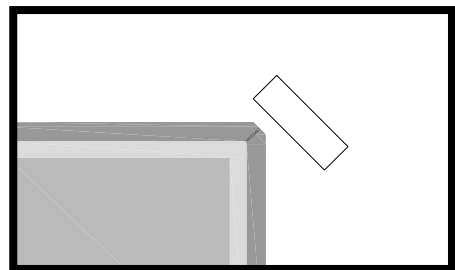

9 - Remove excess grout with a sponge moistened in warm water and alcohol (\*).

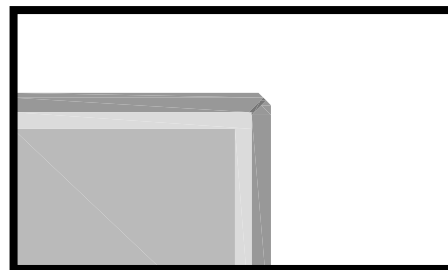

10 - The corner is now ready.

3.3.2 - Solution 2

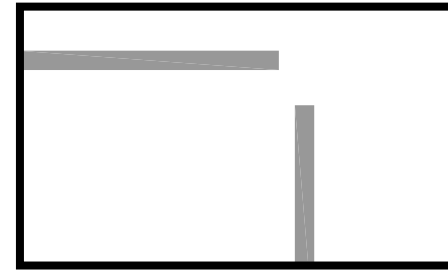

1 - SLIMTECH tile in all its versions.

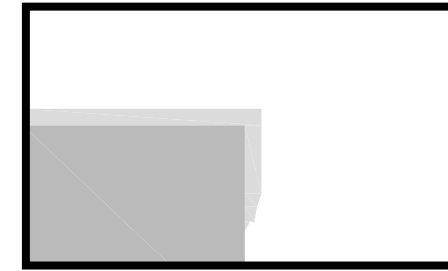

2 - Spread adhesive on the support.

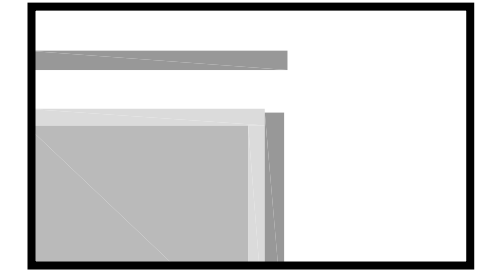

3 - Install the first slab.

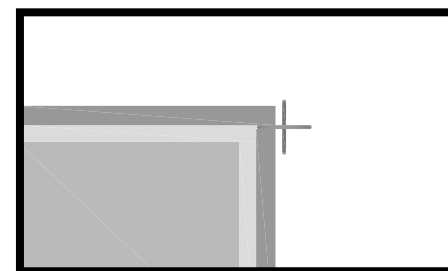

4 - Lay the second slab using 1 mm cross spacers.

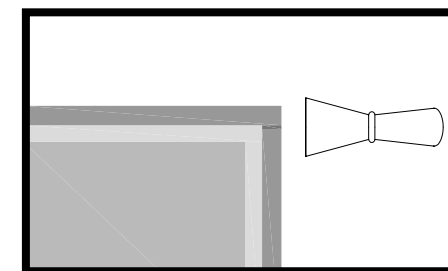

5 - After adhesive has cured, apply epoxy grout with a trowel (\*).

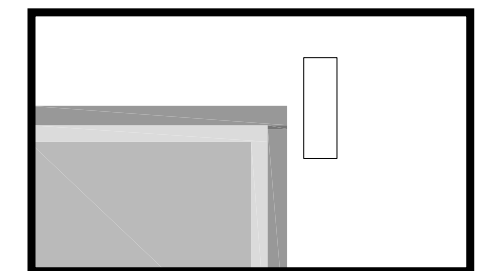

6 - Remove excess grout with a sponge moistened in warm water and alcohol (\*).

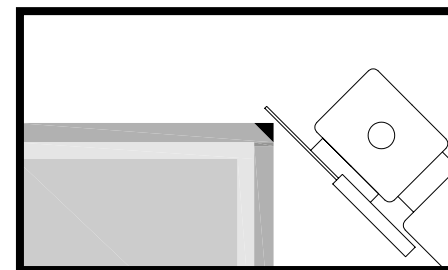

7 - After grout has cured, provide a 45° cut with a hand-held angle grinder or grinder fitted on a guide, such as the 36B bevelling machine made by Sigma (\*).

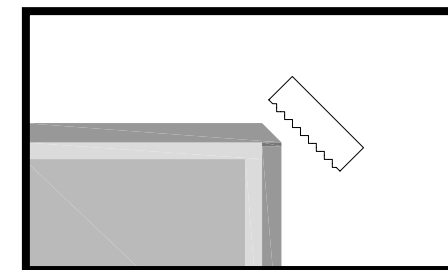

8 - Sand the edge with a diamond finished sponge or grinder disc mounted on a hand-held grinder.

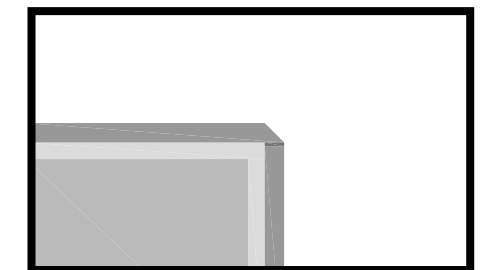

9 - The corner is now ready.

 (\*) To perform this operation, strictly follow the instructions provided by the epoxy grout manufacturer.



## INSTALLING THE VARIOUS VERSIONS OF SLIMTECH

Like all building materials, SLIMTECH works in combination with other materials. **For this reason, it is essential to:**

- define the characteristics of the support on which the tiles will be installed (see "4.1 - Supporting material");
- choose an adhesive that is suitable for the support and intended use (see "4.2 - Recommended adhesives");
- Install SLIMTECH on the support in the correct manner (see "4.3 - Instructions for installation").

If the requirements of these three points are fulfilled, SLIMTECH will offer all the best of its unique characteristics.

### 4.1 - Supporting material

#### 4.1.1 - Supporting material: requirements

The support on which the tiles will be installed **must** have the characteristics best explained hereunder. Verifying and checking these conditions is the responsibility of the designer and of the persons performing installation work.

##### ■ DRY

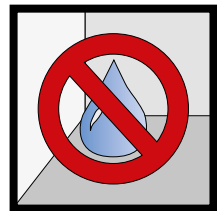

**Fig.23** - This test can be performed using a hygrometer for building materials. A moisture content of less than 2% before installation is acceptable.

##### ■ FLAT

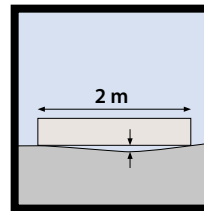

**Fig.24** - Planarity testing is performed using a straightedge with a length of at least 2 metres. Place the rod on the slab in all directions. The permissible tolerance is 2 mm.

##### ■ STABLE OVER TIME

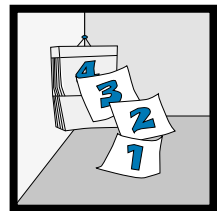

**Fig.25** - The support must have suitable features for the intended use and must remain stable over time.

##### ■ CLEAN



**Fig.26** - The surface of the support must be clean. Dust, oil, grease, dirt and debris must be removed as they may compromise adhesion.

##### ■ NO CRACKS



**Fig.27** - Before installation, seal any cracks and holes.

#### 4.1.2 - Support: most common types of substrates

Market research shows that the most used types of support have the features described above (see "4.1.1 - Support: necessary characteristics").

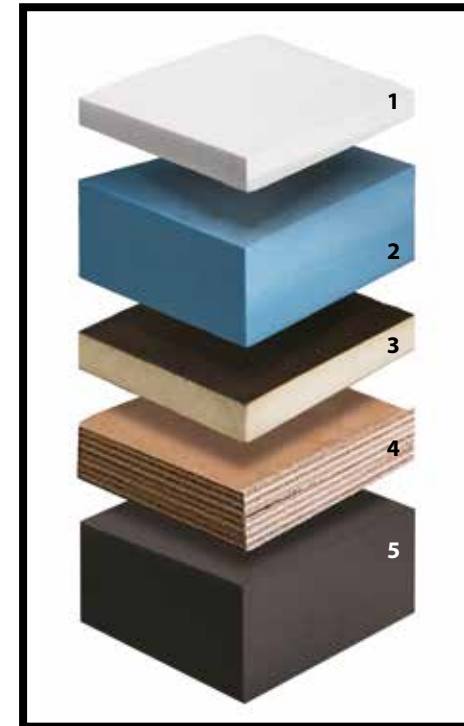

##### 1. Resin-marble slabs

It is obtained by mixing the natural marble, previously crushed (available in different grain sizes), with special resins and poured in moulds that produce blocks, which are then cured, cut to slabs and finished.

##### 2. High density polystyrene

Rigid high density polystyrene panel. Its excellent performance, dimensional stability and ease of installation make it one of the most popular materials used.

##### 3. WEDI type panels

Panel made from extruded polystyrene foam that has a hardening layer without cement substances on both sides, and is covered by a non-woven fabric.

##### 4. Marine plywood panel

Panel consisting of several layers of noble wood veneers. It is a type of lightweight rigid multi-layer wood, that is very resistant to moisture.

##### 5. Various agglomerates

Panels are made with poor materials properly crushed and mixed, and then compacted through the use of specific binding products.

### 4.2 - Recommended adhesives

As a general rule, there is no one universal product that is suitable for all building materials to be bonded in place with adhesive on all kinds of substrate. This general rule applies to SLIMTECH.

As a result of market research at companies that operate in the field of kitchen countertops, and after consulting major manufacturers of adhesives, it can be said that a good adhesive for the realisation of a kitchen countertop must:

- Ensure a perfect adhesion between support and tile;
- Withstand small movements and/or expansions of the support;
- Result in the lowest possible thickness.

Usually who is responsible for the construction of the countertop selects a manufacturer of adhesives and together they identify the most adequate adhesive according to the manufacturing requirements. The types most commonly used are:

- Two-component, with chemical catalyst to accelerate the drying time.
- Epoxy adhesives;
- Fast setting epoxy adhesives;
- Polyurethanic (such as Ultrabond I730 and Ultrabond I420 by **Mapei**);
- Mastics;
- MS polymer (such as Ultrabond I405 by **Mapei**).

The method of application of the adhesive differs according to the product being used; then follow the indications given by the manufacturer of the adhesive.

### 4.3 - Instructions for installation

The tile-laying technique is very different if you are working on a small-scale or semi industrial context. Below we illustrate the laying in a small-scale context.

In all situations, all versions of SLIMTECH can be installed both with a single-layer of adhesive "single buttering" or with a double layer of adhesive "double-buttering". In all cases, follow the indications below and make sure that support and tile have a 100% adhesion.

The method of application of the adhesive differs according to the product being used; follow the indications given by the manufacturer of the adhesive.

#### 4.3.1 - Instructions for manual installation: applying adhesive

##### SINGLE-LAYER METHOD



**Fig.28** - This method refers **only** to adhesives that bear the indication "single-layer" by the manufacturer. Spread adhesive on the complete surface of the support. Follow the instructions of the manufacturer of the adhesive as regards type of spatula and spreading methods.

##### DOUBLE-LAYER METHOD

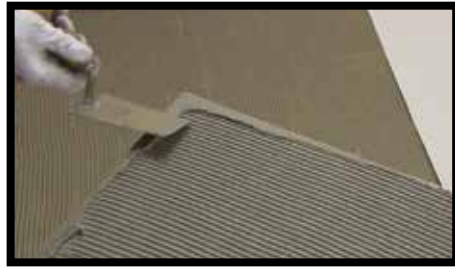

**Fig.29** - Apply adhesive with the double-layer technique i.e. by spreading a full bed adhesive on the surface, using a 6mm square notched trowel (e.g. **Raimondi** item n°138HFV6). Then apply the adhesive also to the rear of the slab using a 3 mm square notched trowel. Remember to add extra adhesive on the corners of the tile.

##### COMPRESSING THE TILE



**Fig.30** - After laying the tile, make sure it is firmly bound to the underlying surface to prevent gaps and air bubbles forming. For this purpose you must use a tile beater with a rubber bottom (for example **Raimondi** "142G").

#### 4.3.2 - Instructions for manual installation: installing the tile

Being extremely light, tiles are easy to install.

**The 300x100 format tiles:**



**Fig.31** - To handle tiles, raise them to their upright position, whilst grasping them from the top edge. They can then be moved with the help of a second person.



**Fig.32** - Rest the slab on its long side and guide it down towards the floor.

#### The Frame

To safely handle SLIMTECH tiles, in all versions and in the 300x100 cm format, a special frame is available upon demand. It is made of aluminium and includes suction cups.

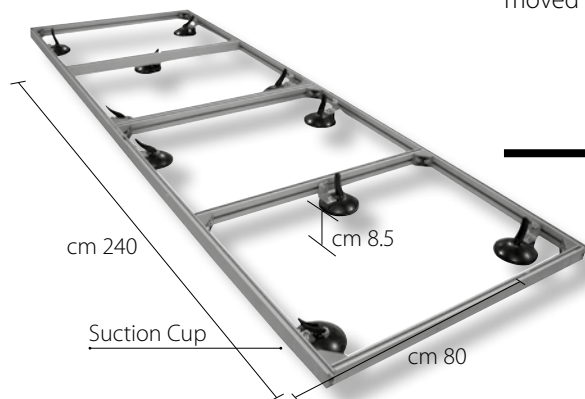

### CONNECTING PROFILES, FINISHING AND TRIM PIECES





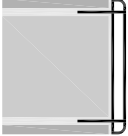
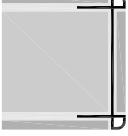

**You can finish all versions of SLIMTECH with the profiles available on the market.**

Here below you will find some possible solutions using the profiles sold by the main manufacturers on the market. The solutions listed hereunder have different technical characteristics and design, depending on the manufacturer. For reasons of lack of space these are not being presented in detail on this manual. The drawings and instructions are therefore indicative and generic. For more information and to acquire an exhaustive idea of the complete ranges offered, refer to the manufacturer. You will find a list of producers in "7 - Useful contacts".

PROFILITEC S.p.A.	www.profilitec.com	PROGRESS PROFILES	www.progressprofiles.com
SCHLÜTER-SYSTEMS ITALIA SRL	www.schlueter.it	PROFILPAS	www.profilpas.com
WEDI	www.wedi.it	DURAL	www.dural.de/en
RARE	www.rareboxdoccia.com		

PROFILES FOR KITCHEN CUPBOARD DOORS AND COUNTERTOPS	Manufacturer	Most sold products
Full profile		
	Profilitec	Planotec BP
	Progress Profiles	Protop
Profiles with tile compartment		
	Progress Profiles	Protect J, T, Q

PROFILES FOR EXTERNAL ANGLES	Manufacturer	Most sold products
Profiles for protruding steps		
	Schlüter®-Systems	Rondec
	Progress profiles	Prostyle KL10
	Profilpas	Prostep
Rounded profile		
	Profilitec	Roundjolly RJ
	Schlüter®-Systems	Rondec
	Progress Profiles	Projolly Quart
	Profilpas	Protrim
Straight edge profile		
	Profilitec	Squarejolly SJ
	Schlüter®-Systems	Quadec
	Progress Profiles	Projolly Square
	Profilpas	Proangle Q
	Dural	Squareline
Thin corner profile		
	Profilitec	Mosaictec RJF
	Progress Profiles	Prokerlam LINE
	Profilpas	Probord IPA
Corner profiles		
	Profilitec	Stairtec SE
	Schlüter®-Systems	ECK-K
	Progress Profiles	Proedge
	Profilpas	Procorner
	Dural	Duragard

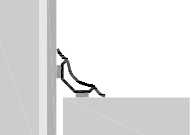
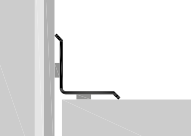
PROFILES FOR INTERNAL ANGLE	Manufacturer	Best-selling products
Obtuse angle profiles		
	Profilitec	Sanitec SB
	Schlüter® -Systems	ECK-KHK
	Progress Profiles	Proseal
	Profilpas	Saniboard
	Dural	Duracove
Right angle profiles		
	Schlüter® -Systems	ECK-KI
	Progress Profiles	Probat
	Profilpas	Saniboard

CURVED PROFILES	Manufacturer	Most sold products
Metal profile for curves		
	Profilitec	Curveline
	Schlüter® -Systems	Schiene
	Progress Profiles	Curve
	Profilpas	Proflex Line
	Dural	Z-FLEX



## KITCHEN COUNTERTOP CLEANING INSTRUCTIONS

### 6.1 - Day to day cleaning

SLIMTECH is very easy to clean and does not require special maintenance.

For daily care, use neutral detergents diluted with plenty of hot water. Detergents should not contain wax or leave glossy stains. Dry with a good quality microfibre cloth. Rinse with water once cleaned and clean off the water using another dry microfibre cloth.



The detergents used should be diluted on the basis of information provided on the product packaging.

Carry out a first cleaning upon the installation of the kitchen countertop in order to remove traces or residues of mastics and silicones possibly used during installation.

With time and with the use of ordinary detergents sold commercially, opaque films can be formed on the surface of the plate. Some drinks such as Coca Cola®, water and wine, if spilt on the surface of the tile could eliminate these films and restore the original appearance. The "stains" created by drinks will be the only really clean parts of the tile. To avoid the formation of these waxes, and opaque stains, it is recommended to use only neutral detergents for routine cleaning. To remove the above mentioned stains the entire surface of the tile must be "dewaxed".

Neutral, wax-free detergent list	
(*) Follow the instructions given on the package. Test the product before actual use. This applies in particular to honed or polished products.	
Name of detergent	Manufacturer
Floor Cleaner Fila Cleaner Pflegerreiniger HMK P15 Bonamain Plus Bonadecon	Faberchimica Fila Lithofin HMK Bonasystems Italia Bonasystems Italia

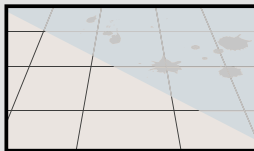
! **If daily cleaning has been done using unsuitable detergents**

Support to clean	What do you see?	What should you do?
SLIMTECH	Glossy stains  It stains, absorbs 	Apply a slightly acidic detergent (such as Tile Cleaner by FABERCHIMICA or Bonamain PLUS the Bonasystems Italia ) undiluted and leave for 5-10 minutes. Rub with a white pad, rinse well with water and dry with microfibre cleaning cloth.

#### 6.1.1 - Resistance to cold liquids

EN 12720 - RESISTANCE TO COLD LIQUIDS				
Products	Contact Time			
	16 hours	1 hour	10 min	10 sec
Acetic acid (10 % aqueous solution)	5	/	/	-
Acetone	5	-	-	/
Ammonia (10 % aqueous solution)	5	/	/	-
Red Wine	5	/	/	-
Citric acid (10 % aqueous solution)	5	/	/	-
Detergent Solution	5	/	-	-
Coffee	5	/	-	-
Chloramine T (2.5% aqueous solution)	5	/	/	-
Ethanol (48% aqueous solution)	5	/	/	-
Ethyl-butyl acetate (1:1)	5	-	-	/
Olive Oil	5	/	/	-
Paraffin oil	5	/	-	-
Sodium Carbonate (10 % aqueous solution)	5	/	-	-
Sodium chloride (15% aqueous solution)	5	/	-	-
Tea	5	/	-	-
Distilled water	5	/	-	-
Lager Beer	5	/	/	-

Evaluation of the results	
/	Not necessary
-	Not required by UNI 10944

CATAS procedure <sup>(**)</sup> - RESISTANCE TO COLD LIQUIDS (CLEANING PRODUCTS)	
Products	Contact Time: 16 hours
Cif Gel with bleach	5 (No change)
Cif Spray active with bleach	5 (No change)
Cillit Bang limestone and dirt	5 (No change)
Cif Power Cream Kitchen	5 (No change)
Ajax Classic Universal	5 (No change)
Glassex with ammonia	5 (No change)
Multipurpose Sanitizing Vetril	5 (No change)
Ace bleach	5 (No change)
Viakal	5 (No change)
Denatured alcohol	5 (No change)
Ammonia (sol.6 / 7 %)	5 (No change)
Mastro Lindo	5 (No change)
Ajax floors	5 (No change)
Rio Casamia floors	5 (No change)
Lysoform Casa	5 (No change)

Evaluation of the results	
	Contact Time: 16 hours
5	No change
4	Slight level of change
3	Moderate level of Change
2	Significant level of Change
1	Very high level of change

### 6.2 - Heavy cleaning

In general it is recommended to proceed with a first cleaning process with warm water and a mild detergent.

If this operation is not sufficient, one can proceed to more aggressive cleaning techniques, depending on the nature of the stain.

It is very important to respect the information in the data sheets and labels of the products used.

With the use of cleaners listed below, it is recommended to pay special attention, as they are particularly aggressive, especially around the cooking hob, sink and in any adjacent elements that are not made of laminated porcelain.

Support to clean	Type of dirt	What to use	Instructions	Name of detergent	Manufacturer
SLIMTECH	Coffee, Coca Cola®, fruit juice	Detergent Alkaline-based	Follow the instructions given by the manufacturer of the detergent.	Coloured stain remover PS87 Greslind	Faberchimica Fila PanariaGroup
	Wine	Oxidising detergent	Follow the instructions given by the manufacturer of the detergent.	Oxidant	Faberchimica
	Lime residues	Acid-based detergents	Follow the instructions given by the manufacturer of the detergent. Test the product on the tiles before use. This applies in particular to honed or polished products.	Viakal	Procter & Gamble
	Rust	Acid-based detergents	Dilute the product and apply directly on the stain. Allow to act for 10/20 minutes then rinse thoroughly. If necessary repeat. Test the product on the tiles before use. This applies in particular to honed or polished products.	Diluted muriatic acid	(various manufacturers))
	Pencil marks and metal marks	Abrasive paste	Follow the instructions given by the manufacturer of the detergent. Test the product on the tiles before use. This applies in particular to honed or polished products.	Polishing cream Vim clorex Detergum (*) Strong remover (*) (*) DO NOT use on lapped or polished products.	Faberchimica Guaber Zep Italia Faberchimica
	Ink, felt-tip pen	Detergent solvent based	Solvents should be applied undiluted directly on the stain. Let them act for about 15/30 seconds. If necessary repeat. As far as "Coloured stain remover" is concerned, follow the manufacturer's instructions.	Nitro thinner 1,2-dichloroethylene Turpentine / white spirit Coloured stain remover	(various manufacturers) (various manufacturers) (various manufacturers) Faberchimica
	Nail polish	Detergent solvent based	Solvents should be applied undiluted directly on the stain. Let them act for about 15/30 seconds. If necessary repeat.	Acetone Solvent for nail polish	(various manufacturers) (various manufacturers)
	Dirt from grout	Detergent for grout	Follow the instructions given by the manufacturer of the detergent.	Fuganet Fugenreiniger	Fila Lithofin

## USEFUL CONTACTS

The companies mentioned in this manual are the result of internal research and are therefore recommended but not obligatory.

---

**Adhesives**
**MAPEI S.p.A.**

Via Cafiero 22  
20158 (MI) - Italy  
Tel. +39 02 37673  
[www.mapei.it](http://www.mapei.it)

---

**Cutting discs / Diamond and abrasive discs / Drill bits**
**DIAMANT CENTER - TYROLIT S.r.l.**

Via Valle d'Aosta, 12  
41049 Sassuolo (MO) - Italy  
Tel. +39 0536 808166  
Fax +39 0536 808211  
[www.diamantcenter.it](http://www.diamantcenter.it)

**MONTOLIT S.p.A.**

Via Turconi, 25  
21050 Cantello (VA) - Italy  
Tel. +39 0332 419211/417744  
e-mail [info@montolit.com](mailto:info@montolit.com)  
[www.montolit.com](http://www.montolit.com)

**RAIMONDI S.r.l.**

Via Dalla Casta, 300/A  
41100 Modena (MO) - Italy  
Tel. +39 059 280888  
Fax +39 059 282808  
[www.raimondiutensili.it](http://www.raimondiutensili.it)

**RUBI ITALIA S.r.l.**

Via Radici in Piano, 596/A  
41049 Sassuolo (MO) - Italy  
Tel. +39 0536 810984  
Fax +39 0536 810987  
e-mail [rubitalia@rubi.com](mailto:rubitalia@rubi.com)

**WÜRTH S.r.l.**

Via Stazione, 51  
39044 Egna (BZ) - Italy  
Tel. +39 06 90779001  
Fax +39 06 90386201  
e-mail [clienti@wuerth.it](mailto:clienti@wuerth.it)

---

**Notched and rubber coated trowels**
**RAIMONDI S.r.l.**

Via Dalla Casta, 300/A  
41100 Modena (MO) - Italy  
Tel. +39 059 280888  
Fax +39 059 282808  
[www.raimondiutensili.it](http://www.raimondiutensili.it)

---

**Tile cutters / Glass cutters  
Abrasive sponges**
**BOHLE ITALIA S.r.l.**

Via Cavallotti, 28  
20081 Abbiategrasso (MI) - Italy  
Tel. +39 02 94967790  
Fax +39 02 94609011  
e-mail [Italia@Bohle.de](mailto:Italia@Bohle.de)

**WÜRTH S.r.l.**

Via Stazione, 51  
39044 Egna (BZ) - Italy  
Tel. +39 06 90779001  
Fax +39 06 90386201  
e-mail [clienti@wuerth.it](mailto:clienti@wuerth.it)

---

**Tile cutter rulers**
**SIGMA S.n.c.**

Via A. Gagliani, 4  
47813 Igea Marina Bellaria (RN) - Italy  
Tel. +39 0541 330103  
Fax +39 0541 330422  
[www.sigmailta.com](http://www.sigmailta.com)

**RAIMONDI S.r.l.**

Via Dalla Casta, 300/A  
41100 Modena (MO) - Italy  
Tel. +39 059 280888  
Fax +39 059 282808  
[www.raimondiutensili.it](http://www.raimondiutensili.it)

---

**Profiles and trim pieces**
**PROFILITEC S.p.A.**

Via Brescia, 43  
36040 Torri di Quartesolo (VI) - Italy  
Tel. +39 0444 268311  
Fax +39 0444 268310  
[www.profilitec.com](http://www.profilitec.com)

**SCHLÜTER-SYSTEMS Italia S.r.l.**

Via Bucciardi 31/33  
41042 Fiorano Modenese (MO)  
Tel. +39 0536 914511  
Fax +39 0536 911156  
[www.schluter.it](http://www.schluter.it)

**PROGRESS PROFILES S.p.A.**

Via Le Marze, 7  
31011 Asolo (TV) - Italy  
Tel. +39 0423 950398  
Fax +39 0423 950979  
[www.progressprofiles.com](http://www.progressprofiles.com)

**PROFILPAS S.p.A.**

Via Einstein, 38  
35010 Cadoneghe (PD) - Italy  
Tel. +39 049 8878411  
Fax +39 049 706692  
[www.profilpas.com](http://www.profilpas.com)

**DURAL GmbH & Co.**

Via Oberdan, 11  
40126 Bologna (BO) - Italy  
Tel. +39 051 0971513  
Fax +39 051 0971513  
[www.dural.com](http://www.dural.com)

**WEDI ITALIA S.r.l.**

Via Redipuglia, 32  
20035 Lissone (MI) - Italy  
Tel. +39 0392 459420  
[www.wedi.it](http://www.wedi.it)

**RARE S.r.l**

Via delle Brughiere, 12  
21050 Cairate (VA) - Italy  
Tel. +39 0331 360360  
Fax +39 0331 360168  
[www.rareboxdoccia.com](http://www.rareboxdoccia.com)

---

**Detergents**
**MAPEI S.p.A.**

Via Cafiero 22  
20158 (MI) - Italy  
Tel. +39 02 37673  
[www.mapei.it](http://www.mapei.it)

**FABERCHIMICA S.r.l.**

via G. Ceresani, 10 - Località Campo d'Olmo  
60044 Fabriano (AN) - Italy  
Tel. +39 0732 627178  
[www.faberchimica.com](http://www.faberchimica.com)

**FILA Industria Chimica S.p.A.**

via Garibaldi, 32  
35018 S. Martino dei Lupari (PD) - Italy  
Tel. +39 049 9467300  
[www.filachim.it](http://www.filachim.it)

**ZEP Italia S.r.l.**

via Nettunese, Km 25,000  
04011 Aprilia (LT) - Italy  
Tel. +39 06 926691  
[www.zepitalia.it](http://www.zepitalia.it)

**JOHNSON DIVERSEY S.p.A.**

via Meucci, 40  
20128 Milan - Italy  
Tel. +39 0373 2051  
[www.johnsondiversey.com](http://www.johnsondiversey.com)

**KITER S.r.l.**

via Assiano, 7/B  
20019 Settimo Milanese (MI) - Italy  
Tel. +39 02 3285220  
[www.kiter.it](http://www.kiter.it)

**GEAL S.r.l.**

via Settola, 121  
51031 Agliana (PT) - Italy  
Tel. +39 0574 750365  
[www.geal-chim.it](http://www.geal-chim.it)

**FEDERCHEMICALS S.r.l.**

via G. Borsi, 2  
25128 - Brescia - Italy  
Tel. +39 030 3390880  
Fax +39 030 3385580  
[www.federchemicals.it](http://www.federchemicals.it)

---

**Detergents**
**LITHOFIN-Produkte GmbH**

Postfach 1134,  
D-73236 Wendlingen (D)  
Tel. 0049 07024/940320  
[www.lithofin.de](http://www.lithofin.de)  
Vertrieb für Österreich:  
CT-Austria Ges.m.b.H. A-1230 Wien  
Tel. +43 01 8673434

**HMK - MÖLLER-CHEMIE**

Benelux GmbH - Linge 4  
NL-2105 WB Heemstede (NL)  
Tel. +31 0252 220222  
[www.moellerchemie.de](http://www.moellerchemie.de)

**BONASYSTEMS ITALIA S.r.l.**

Via Borgo S. Chiara, 29  
30020 Torre di Mosto (VE) - Italy  
Tel. +39 0421 325691  
Fax +39 0421 324232  
[www.bonasytemsitalia.it](http://www.bonasytemsitalia.it)

**LITOKOL S.p.A**

Via G. Falcone, 13/1  
42048 Rubiera (RE) - Italy  
Tel. +39 0522 622811  
Fax. +39 0522 620150  
e-mail [info@litokol.it](mailto:info@litokol.it)  
[www.litokol.it](http://www.litokol.it)









# LEA

CERAMICHE

LEA CERAMICHE  
Via Cameazzo, 21  
41042 Fiorano Modenese  
Modena Italy

Tel +39 0536 837811  
Fax +39 0536 830326  
info@ceramichelea.it  
www.ceramichelea.com  
slimtech.ceramichelea.it

Panariagroup Industrie Ceramiche S.p.A.

SHOWROOM LEA CERAMICHE  
Via Durini, 3  
20122 Milano

Tel +39 02 76011406  
showroom\_milano@ceramichelea.it

LEA NORTH AMERICA, LLC  
800 Clanton Road, Suite N  
Charlotte, NC 28217

Tel +1 704 522 6300  
Fax +1 704 522 6080  
info@leausa.us